



INSTRUCTIONS D'ASSEMBLAGE
ASSEMBLY INSTRUCTIONS

MONARCH
SPECIALTIES INC.

I 3065

ENS SALLE A MANGER -
3PCS / METAL & MARBRE GRIS

DINING SET -
3PCS SET / GREY MARBLE / CHARCOAL METAL



**POUR DE L'ASSISTANCE OU POUR COMMANDER
DES PIÈCES CONTACTEZ NOTRE DÉPARTEMENT
DE SERVICE À LA CLIENTÈLE.**



**FOR ASSISTANCE OR TO ORDER PARTS
CONTACT OUR CUSTOMER SERVICE DEPARTMENT**

WWW.MONARCHSERVICE.COM

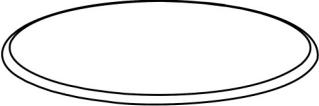
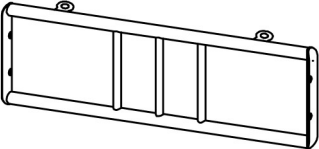
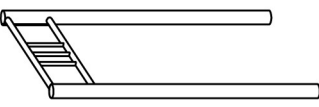
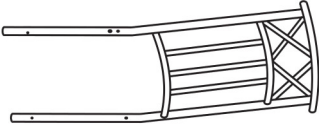
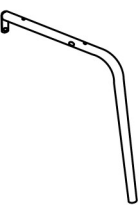
LISTE DES PIÈCES
PARTS LIST

PIÈCE / PART #	IMAGE	DESCRIPTION	QTY / QTÉ
1		TABLE TOP SURFACE DE TABLE	1
2		SIDE FRAME CADRE DE CÔTÉ	2
3		TABLE LEG PATTE DE TABLE	2
4		CHAIR BACK DOSSIER	2
5		FRONT FACING LEFT LEG PATTE AVANT GAUCHE	2

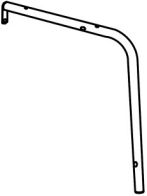
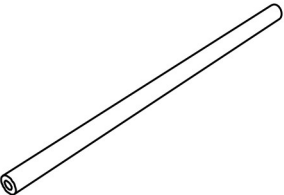

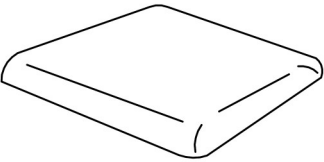
LISTE DES PIÈCES
PARTS LIST

PIÈCE / PART #	IMAGE	DESCRIPTION	QTY / QTÉ
6		<p align="center">FRONT FACING RIGHT LEG PATTE AVANT DROITE</p>	2
7		<p align="center">SUPPORT BAR BARRE DE SOUTIEN</p>	2
8		<p align="center">CROSSBAR (CHAIR) BARRE TRANSVERSALE DE PATTE</p>	2
9		<p align="center">CROSSBAR (CHAIR) BARRE TRANSVERSALE DE PATTE</p>	2
10		<p align="center">CHAIR SEAT CUSHION COUSSIN</p>	2

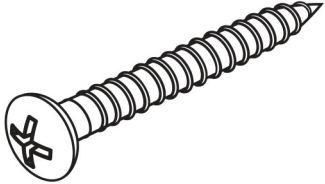
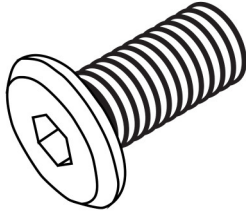
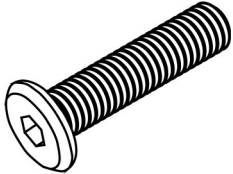
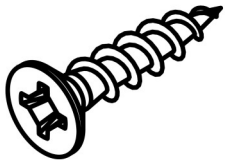
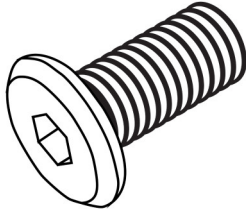
LISTE DES PIÈCES DE MONTAGE
HARDWARE LIST

PIÈCE / PART #	IMAGE	DESCRIPTION	QTY / QTÉ
A		ASSEMBLING SCREW - Ø 1/4" X 1 1/4" VIS D'ASSEMBLAGE - Ø 1/4" X 1 1/4"	8
B		ASSEMBLING BOLT - Ø 1/4" X 1/2" BOULON D'ASSEMBLAGE - Ø 1/4" X 1/2"	20
C		ASSEMBLING BOLT - Ø 1/4" X 1 3/8" BOULON D'ASSEMBLAGE - Ø 1/4" X 1 3/8"	8
D		ASSEMBLING SCREW - Ø 1/4" X 1/2" VIS D'ASSEMBLAGE - Ø 1/4" X 1/2"	4
E		ASSEMBLING BOLT - Ø 1/4" X 5/8" BOULON D'ASSEMBLAGE - Ø 1/4" X 5/8"	2

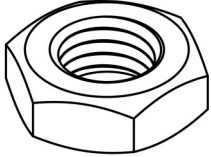
LISTE DES PIÈCES DE MONTAGE
HARDWARE LIST

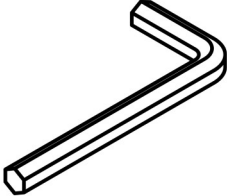
PIÈCE / PART #	IMAGE	DESCRIPTION	QTY / QTÉ
F		HEX NUT - Ø 1/4" ÉCROU HEXAGONALE - Ø 1/4"	2
G		SPANNER CLÉ ANGLAISE	1
H		HEX KEY CLÉ HEXAGONALE	1



OUTIL DE VÉRIFICATION DE DIMENSIONS DES PIÈCES
HARDWARE DIMENSIONS VERIFICATION TOOL



ÉTAPE / STEP 1

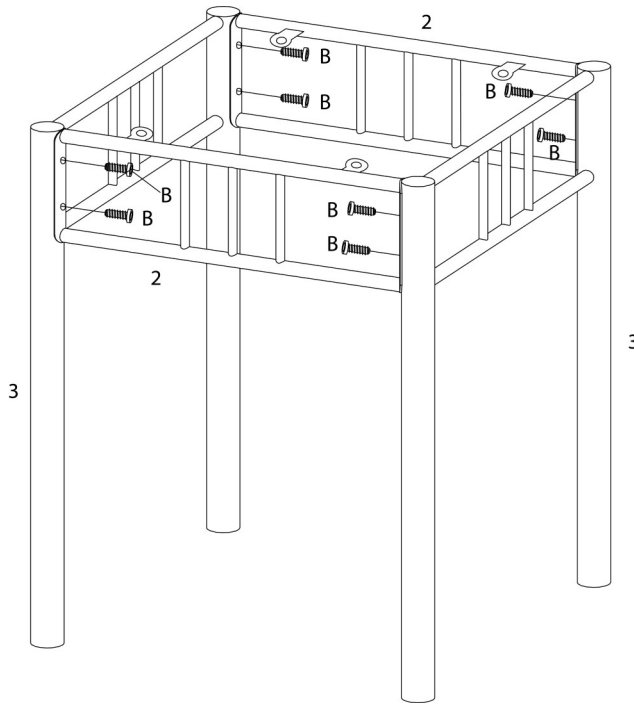

ÉTAPE / STEP 2

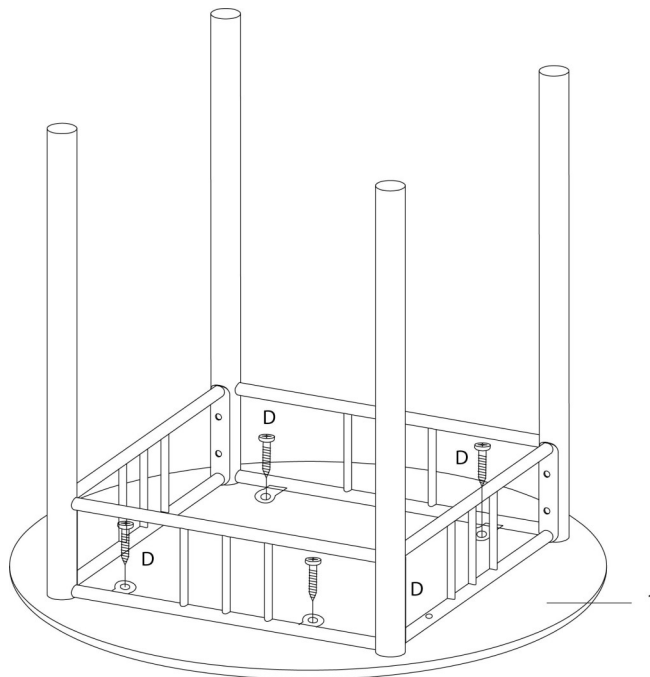

ÉTAPE / STEP 3

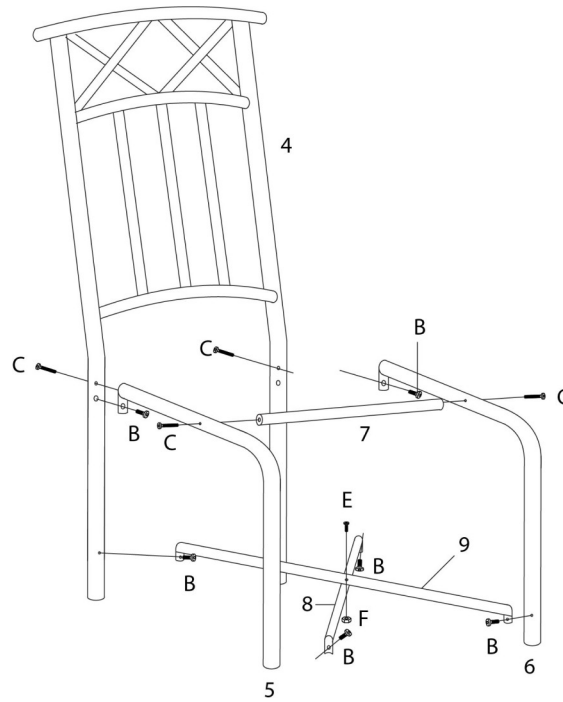

ÉTAPE / STEP 4

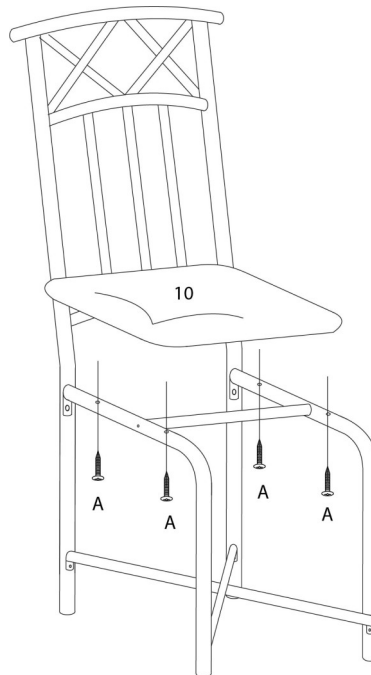

ÉTAPE / STEP 5

